

## **PART 1: ISCST3 DATA PREPARATION FROM CIMIS WEATHER STATION DATA**

Edgar Vidrio  
Environmental Scientist

Bruce Johnson  
Research Scientist III

January 2011; Revised 2014

Updated by Christopher Collins  
Environmental Scientist

**March 2017**

California Environmental Protection Agency  
Department of Pesticide Regulation  
Environmental Monitoring Branch  
Air Program  
P.O. Box 4015  
Sacramento, California 95812-4015

## TABLE OF CONTENTS

|   |          |
|---|----------|
| List of Figures .....   | iii      |
| List of Tables.....   | iii      |
| <b>1. Introduction .....</b>  | <b>1</b> |
| <b>2. Objectives.....</b>   | <b>1</b> |
| <b>3. Methods .....</b>   | <b>2</b> |
| 3.1 Meteorological data .....   | 2        |
| 3.2 CIMIS quality control flags .....   | 4        |
| 3.3 Data Processing .....   | 4        |
| 3.4 Stability classification .....  | 6        |
| 3.5 Software Revisions .....  | 6        |
| <b>4. Results .....</b>   | <b>6</b> |
| 4.1 Location of files .....   | 6        |
| 4.2 Verification of revised PREFORMV2, CIMPRO1V4, CIMPRO2V5, and MAKISCV2 programs .....                    | 7        |
| 4.3 Validation of CIMPRO2V5 determined stability.....   | 7        |
| 4.4 Calms determination.....  | 7        |
| <b>5. Summary .....</b>   | <b>8</b> |
| <b>6. References.....</b>   | <b>8</b> |
| Appendix 1: Summary of missing days for 90 years of CIMIS meteorological data.....                          | 10       |
| Appendix 2: Recommended procedures and tutorial processing for yearly CIMIS data sets into .ISC files ..... | 14       |
| Appendix 3: Recommended procedures and tutorial to create Wind Rose graphs from .ISC files .....            | 18       |
| Appendix 4: Manual versus CIMPRO2V5 determined stability classifications.....                               | 20       |

**LIST OF FIGURES**

Figure 1. Location Map from CIMIS web site to show stations 70 and 166 in San Joaquin County used in this report. .... 3

Figure 2. Location Map from CIMIS web site to show the following stations used in this report: 80 and 105 (Fresno), 15 and 21 (Kings), 125 and 146 (Kern), 145 (Madera), 56 and 148 (Merced), 89 and 113 (Monterey), 161 and 194 (Stanislaus), 86 and 182 (Tulare). .... 3

Figure 3. Location Map from CIMIS web site to show station 156 in Ventura County. .... 4

Figure 4. Schematic representation of the folder tree where the ISC and Support Files are located in DPR’s Air\_Emergency\_Proj drive. .... 7

**LIST OF TABLES**

Table 1. Pesticide use report for all active ingredient applications during 2008. Ranking is based on total pounds applied during this year period. .... 2

Table 2. Adjustment to wind direction standard deviation categories for roughness and 2 meter wind measurement height for CIMIS data (Taken from Johnson 2001, Table 4.4). .... 6

## 1. Introduction

The Industrial Source Complex Short Term Version 3 (ISCST3) model is a steady-state Gaussian plume model which can be used to assess pollutant concentrations from a variety of sources (USEPAab, 1995). The Department of Pesticide Regulation (DPR) utilizes the ISCST3 model in its air program for analyzing fumigant applications (Barry et al., 1996; Fan et al., 2008), determining buffer zones (Barry and Johnson, 2007; Barry 2007), estimating long-term exposures, and for other activities (Ross et al., 1996).

To use the ISCST3 model, the user needs a specially formatted file that contains the following hourly meteorological data:

- Date and Time of hourly record
- Air Temperature
- Wind Direction
- Wind Speed
- Stability Class
- Urban and rural mixing heights

When specific site meteorological data is not available, the Air Program has used data from the California Irrigation Management Information System (CIMIS). CIMIS is an automated meteorological data collection program which collects from stations throughout agricultural areas in California (CIMIS, 2010). CIMIS provides hourly averages of one-minute data collected at a height of 2m for scalar wind speed, vector wind direction, air temperature, standard deviation of horizontal wind direction, net radiation and other meteorological variables. Reported times are always Pacific Standard Time. Stations are generally located in open, agricultural areas on mowed grass pastures.

Processing CIMIS data for use with ISCST3 has been a tedious and idiosyncratic process. Having processed CIMIS data available for use with ISCST3 will facilitate research in mitigation strategies and comparative simulations. Therefore, it was the intent of this project to establish an ISCST3 meteorological input file database and to detail the steps taken to do so.

Additionally, DPR personnel previously used the following DPR created programs to produce ISCST3 meteorological files from downloaded CIMIS data: PREFORM, MAKISC, CIMPRO1V2, and CIMPRO2V2A. Over time, some of the steps required in these programs were unnecessary and time consuming. Thus, a secondary goal of this report was to streamline and document the use of these programs. Part 1, this document, describes the procedures used to create the meteorological database. Part 2, documents the technical aspects of the software used to create the meteorological database.

## 2. Objectives

The specific objectives for this work were the following:

1. Establish a database of meteorological data for use in ISCST3 modeling for future DPR modeling projects.
2. Document the procedures and software used to process CIMIS meteorological data.

3. Update and streamline the software used for processing CIMIS meteorological data.
4. Establish a set of standardized procedures for collecting and formatting CIMIS meteorological data for ISCST3 modeling.

### 3. Methods

#### 3.1 Meteorological data

Meteorological data were obtained from the CIMIS weather station network for the 10 California counties with the highest pounds of active ingredient applied in 2008 as documented by California's pesticide use report (DPR, 2008). The highest 10 counties in terms of pounds of active ingredient applied were Fresno, Kern, Tulare, Monterey, Madera, Merced, San Joaquin, Ventura, Kings, and Stanislaus (Table 1). The amount applied in the 10 counties represents 71% of the statewide total for 2008.

**Table 1.** Pesticide use report for all active ingredient applications during 2008. Ranking is based on total pounds applied during this year period.

| County       | Pounds Applied     | Rank | CIMIS Stations Selected |
|--------------|--------------------|------|-------------------------|
| Fresno       | 27,543,587         | 1    | 80, 105                 |
| Kern         | 25,441,400         | 2    | 125, 146                |
| Tulare       | 14,310,365         | 3    | 86, 182                 |
| Monterey     | 7,893,327          | 4    | 89, 113                 |
| Madera       | 7,578,258          | 5    | 145                     |
| Merced       | 6,912,082          | 6    | 56, 148                 |
| San Joaquin  | 6,754,501          | 7    | 70, 166                 |
| Ventura      | 6,437,899          | 8    | 156                     |
| Kings        | 6,239,993          | 9    | 15, 21                  |
| Stanislaus   | 5,677,506          | 10   | 161, 194                |
| <b>Total</b> | <b>114,788,918</b> |      |                         |

A total of 18 CIMIS weather stations were selected to represent the counties listed in Table 1. The original intention was to select two CIMIS weather stations from each county listed in Table 1. However, Madera County only had one weather station located within its borders and three stations located in Ventura County were located within close proximity to one another. Therefore, only one weather station was chosen from each Madera and Ventura counties for this report. Two CIMIS weather stations were selected from each of the other 8 California counties listed in Table 1.

A total of 90 whole years of hourly meteorological data (January through December) were downloaded from the CIMIS network website. Appendix 1 shows a summary of missing days for each station. For this report, as previously described elsewhere (Johnson, 2001), a missing day was defined when five or more hours of any of the downloaded variables were missing in one day. Where 4 or fewer hours

during a 24 hour period were missing, linear interpolation was used to fill in the missing values in accordance with USEPA recommendations (USEPA, 2000).

Weather stations from the CIMIS network are generally located on irrigated pastures with grass between 10-15 cm tall, and no obstructions within 100 yards. The locations of stations listed in Table 1 can be found in Figures 1 - 3.

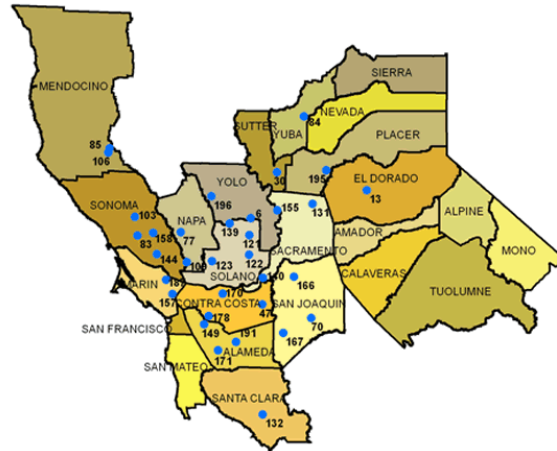

**Figure 1.** Location Map from CIMIS web site to show stations 70 and 166 in San Joaquin County used in this report.

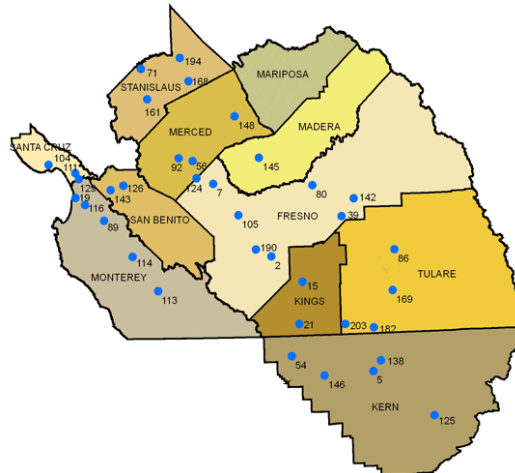

**Figure 2.** Location Map from CIMIS web site to show the following stations used in this report: 80 and 105 (Fresno), 15 and 21 (Kings), 125 and 146 (Kern), 145 (Madera), 56 and 148 (Merced), 89 and 113 (Monterey), 161 and 194 (Stanislaus), 86 and 182 (Tulare).

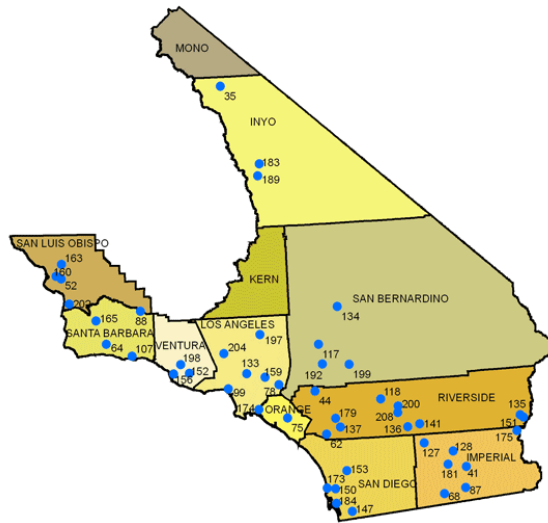

**Figure 3.** Location Map from CIMIS web site to show station 156 in Ventura County.

\*Maps taken from CIMIS Network website: <http://wwwcimis.water.ca.gov/cimis/infoStnMap.jsp>

### 3.2 CIMIS quality control flags

The CIMIS network currently segregates their quality control criteria flags into two main categories: Severe and Informative. Severe flags constitute any missing data (M), sensor malfunction (S), occasions where the data value has no meaning (I), and instances when a quantity was not calculated (N). The Informative category includes a number of flags ranging from Quality test pending (P) to Data far out of historical limits (R). Currently, data flagged with M, S, I, or N, are treated as missing by the CIMIS processing software presented in this report. Further details can be found in Johnson and Vidrio (Part 2 of this document).

Determining whether to include or exclude any R flagged data can be challenging for the program user. Strictly speaking an R value means that the measured value is 3 standard deviations out of historical limits. However, review of selected R flagged data for radiation and temperature, indicated that R flagged values seemed acceptable. However, that was not always the case for wind direction and standard deviation of wind direction. For these categories an R flag occasionally seemed to indicate constant wind direction for several hours, possibly connoting either low wind conditions or a stuck wind direction sensor. These situations can be looked for in the CSS-YY.BJ1 files which contain both the .ISC processed data and pre-processed CIMIS data. Due to this fact, earlier program versions left that decision up to the user, but for the program revision, it was decided as a policy to include R flagged values as acceptable.

### 3.3 Data Processing

Selected whole year's hourly data was downloaded from the CIMIS meteorological network website (<http://wwwcimis.water.ca.gov/>). The data files downloaded contained solar radiation, net radiation, air temperature, wind speed, wind direction, standard deviation of wind direction, and precipitation. All downloaded data were in English units.

The following naming convention was used for saving downloaded CIMIS meteorological data: CSS-YY.UXT, where C stands for CIMIS, SS refers to the CIMIS station number where the data was collected (this value could be either a 2 or 3 digit number), YY refers to the last two digits of the year in which the data collection took place, and .UXT refers that the data file is in UNIX format.

The program UNIXORDOSV2 was first run in a Windows Command Prompt (executable name cmd.exe) window (see Appendix 2) to determine whether the CSS-YY.UXT downloaded CIMIS file was DOS or UNIX formatted. If the program UNIXORDOSV2 returned a "Has normal DOS formatting, there is no need to run UNIX2DOS", then we simply renamed the CSS-YY.UXT into CSS-YY.DXT. However, if the UNIXORDOSV2 program returned an "Appears to be UNIX formatted, you need to run the UNIX2DOS program on it" message, then the CSS-YY.UXT file is formatted from UNIX to DOS using the program named UNIX2DOS. The resulting file was saved using the following name format: CSS-YY.DXT. (Note: if UNIX2DOS is run on a file that's already in DOS format, the resulting file will be corrupted and make further processing impossible).

The CSS-YY.DXT file was then processed using FIXDASHV2 program. This program corrected for any missing data created format problems. Whenever there is missing data from a CIMIS weather station, the CIMIS program places "--" where otherwise the missing values would be placed, thereby changing the position of all data to the right of the missing values. The FIXDASHV2 program automatically adds either a "-99" or "-99.0" to replace missing data values. Determining where to add a "-99" or "-99.0" is based on the column in which the missing data values are contained, as Solar Radiation and Net Radiation data are provided by CIMIS as whole numbers, while Air Temperature, Wind Speed, Standard Deviation of Wind Direction, and Precipitation all contain numbers with at least one decimal place. FIXDASHV2 produced a file named CSS-YY.TXT, which was the input file for the next program.

Following editing by FIXDASHV2, the CSS-YY.TXT file was processed using the program PREFORMV2 (see Appendix 2). This program arranged the CSS-YY.TXT file into the correct format needed for the next DPR program and created a new file named CSS-YY.PRE.

The CSS-YY.PRE file was then processed with CIMPRO1V4 (see Appendix 2). This program produced a summary file (CSS-YY.SUM) which listed the missing values and unusable days. The .SUM file is for information purposes only. The user is not required to take any specific action to remedy missing values. The .SUM file can be deleted at the discretion of the user as it is not needed for further processing. The program also produced a file named CSS-YY.BJ1, which becomes the input for the next DPR program in the process. Briefly, an unusable day is defined as any day with more than 4 hours missing or bad data.

The CSS-YY.BJ1 file was then processed with CIMPRO2V5 (see Appendix 2). This program processed the CSS-YY.BJ1 file and produced a file where the first part of each record was copied from the CSS-YY.BJ1 file, and the second part was the data in ISCST3-ready format. The output file for this program was named YYCIMSSS.2P0, where YY refers to the last two digits of the data year, CIM refers to CIMIS, and SSS stands for the CIMIS station number (if the station number is only composed of two digits, a 0 was added in front of it for naming purposes).

Finally, the newly created YYCIMSSS.2P0 file was processed with MAKISCV2 (see Appendix 2). This program grabbed the last portion of each record in the YYCIMSSS.2P0 file and produced a continuous ISCST3 compatible format for the usable days (unusable days were omitted from this file). The output file named YYCIMSSS.ISC is ready to be used in future ISCST3 modeling with the possible exception that missing days (dates) will be skipped.



### 3.4 Stability classification

Using guidelines set by USEPA (2000), an initial stability classification was determined by utilizing the standard deviation of wind direction. This initial stability classification was then modified depending on wind speed and night versus day. The final stability was determined by allowing no more than one stability class change per hour. For determining night and day, the net radiation was used. Negative net radiation was defined as night and positive is defined as day.

Established cutoff points for standard deviation of wind direction used to determine the initial stability classification do not entirely reflect the 2 meter height used at CIMIS stations, USEPA adjustment equations were used to modify cutoff points (Johnson, 2001). Adjusted cutoff points were determined to be 18.0, 16.2, 11.9, 7.9, 5.1 degrees (Table 2).

**Table 2.** Adjustment to wind direction standard deviation categories for roughness and 2 meter wind measurement height for CIMIS data (Taken from Johnson 2001, Table 4.4).

| Stability Class | Lower Cutoff Bound (degrees) | Roughness Factor                    | Wind Measurement Height Factor |  | Adjusted Cutoff (degrees) |
|-----------------|------------------------------|-------------------------------------|--------------------------------|--|---------------------------|
|                 |                              | $Z_0 = 3\text{cm}$                  | $P_\theta$                     | $Z = 2\text{m}$                        |                           |
|                 |                              | $\left(\frac{Z_0}{15}\right)^{0.2}$ |                                | $\left(\frac{Z}{10}\right)^{P_\theta}$ |                           |
| 1               | 22.50                        | 0.72                                | -0.06                          | 1.10                                   | 18.0                      |
| 2               | 17.50                        | 0.72                                | -0.15                          | 1.27                                   | 16.2                      |
| 3               | 12.50                        | 0.72                                | -0.17                          | 1.31                                   | 11.9                      |
| 4               | 7.50                         | 0.72                                | -0.23                          | 1.45                                   | 7.9                       |
| 5               | 3.80                         | 0.72                                | -0.38                          | 1.84                                   | 5.1                       |

### 3.5 Software Revisions

The existing software was originally written for primary use by B. Johnson. In order to make this software easier to use, detailed operational notes were jointly revised. The main software changes were made to give all programs the same form for running and assigning input and output files. This form is *program name input.file output.file*. The technical manual (Part 2) provides greater detail on technical software aspects.

## 4. Results

### 4.1 Location of files

To properly store all of the created ISCST3-ready files in a commonly accessible location, a folder named "CIMIS-met-process" was placed on the DPR server's Air\_Emergency\_Proj drive. Within the main folder two subdirectory folders named "ISC Files" and "Support Files" (see Figure 4) were added to keep all of the formatted ISCST3-ready files and all supplemental files, respectively. Additionally, to keep all of the programs used to format the CIMIS data in one easy to find location, a subfolder named "programs(BJohnson)" was also created. This program folder contains the revised programs UNIX2DOS, UNIXORDOSV2, FIXDASHV2, PREFORMV2, CIMPRO1V4, CIMPRO2V5, and MAKISCV2 as well as the source

code contained in each of these programs. The subfolders were all organized by County, Station, and Year.

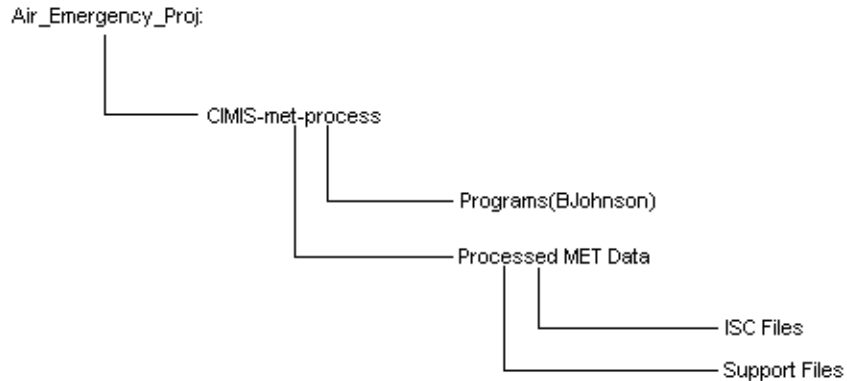

**Figure 4.** Schematic representation of the folder tree where the ISC and Support Files are located in DPR’s Air\_Emergency\_Proj drive.

#### 4.2 Verification of revised PREFORMV2, CIMPRO1V4, CIMPRO2V5, and MAKISCV2 programs

To compare the newly revised programs to the old versions, CIMIS meteorological data was analyzed using both versions of the same program. Using Windows File Compare (FC.EXE) program, which compares two files and displays the differences between them, the output files from both the updated and original programs can be compared to determine whether the same data output is obtained. All new program versions produced the same files with no observable differences as obtained via the FC.EXE program.

#### 4.3 Validation of CIMPRO2V5 determined stability

To confirm CIMPRO2V5 determined stability classifications, three random 24-hour periods were selected from the 90 years worth of CIMIS data and manual stability classifications were performed following the procedure listed in section 3.4. The results were compared to the CIMPRO2V5 determined stability classifications for the same 24-hour periods. Results are shown on Appendix 4. These results verified that CIMPRO2V5 accurately performed stability classifications since the randomly selected 24-hour files gave the identical stability classifications as those manually calculated.

#### 4.4 Calms determination

The term “calm” is used to define the situation when the wind speed is so low that either speed or direction is indeterminate. For the CIMIS network, in which an hourly average is taken from 60 individual one minute measurements, the lowest possible hourly wind speed average is 1 mph (Johnson, 2001). At hourly average speeds near 1 mph, some fraction of the 60 measurements will be “calms”: Previous work set the CIMIS calms threshold at 2.8 mph (Johnson, 2001). For this corrected work, the threshold was set at 2.0 mph in order to include more usable data. The program sets calm hour wind speeds to 0.0 m/s in the final record.

A small subset of the data was analyzed for percentage of calms. Specifically, one complete year of meteorological data was selected from every one of the 18 CIMIS weather stations in the newly created ISC database and analyzed for calm hour percentage using Microsoft Excel’s PivotTables. It was found that in some of the year-long data sets, the percentage of calm hours exceeded 50% for the year. Although these percentages were sometimes far greater than the ARB recommended 10% limit, it does not

preclude using portions of that data set for shorter simulations. Therefore, we opted to include all of the data sets that we processed. It is incumbent upon the user of this data to assess calms frequencies.

## 5. Summary

CIMIS meteorological data was obtained for the 10 California counties with the highest active ingredient applied as documented by the 2008 California's Pesticide Use Report. Using various DPR created programs (UNIXORDOSV2, FIXDASHV2, PREFORMV2, CIMPRO1V4, CIMPRO2V5, and MAKISCV2), ISCST3-ready files were created. A database containing 90 years worth of hourly meteorological data was created and the location listed in this report for future modeling use.

Additionally, verification of updated PREFORMV2, CIMPRO1V4, CIMPRO2V5, and MAKISCV2 program versions was performed. Using File Compare, it was determined that the newly updated programs produce identical results as prior program versions while streamlining the process.

Percentages of calms of the formatted meteorological data were calculated for a few randomly selected files from the 18 CIMIS weather stations included in this report. Although some of the files exceeded 50% calms for the year, it does not preclude using portions of that data set for shorter simulations and thus all of the formatted data was included in the database.

## 6. References

- Barry, T.A., R. Segawa, P. Wofford, and C. Ganapathy. 1996. Off-site air monitoring following methyl bromide chamber and warehouse fumigations and evaluation of the Industrial Source Complex-Short Term 3 Air Dispersion Model. p. 178-188. In J.N. Seiber et al. (ed) Fumigants environmental fate, exposure, and analysis. ACS symposium series 652, American Chemical Society, Washington, DC.
- Barry, T. 2007. Memorandum to Charles Andrews on "Development of Additional Methyl Isothiocyanate Buffer Zones for the Metam Sodium Mitigation Proposal". February 8, 2007. [http://www.cdpr.ca.gov/docs/emon/pubs/ehapreps/analysis\\_memos/1884\\_Andrws\\_MITC.pdf](http://www.cdpr.ca.gov/docs/emon/pubs/ehapreps/analysis_memos/1884_Andrws_MITC.pdf)
- Barry, T., Johnson, B. 2007. Memorandum to Randy Segawa on "Analysis of the Relationship between Percentiles of the Whole Field Buffer Zone Distribution and the Maximum Direction Buffer Zone Distribution". October 23, 2007. [http://www.cdpr.ca.gov/docs/emon/pubs/ehapreps/analysis\\_memos/1959\\_segawa.pdf](http://www.cdpr.ca.gov/docs/emon/pubs/ehapreps/analysis_memos/1959_segawa.pdf)
- CIMIS. 2010. California Irrigation Management Information System. Department of Water Resources. Office of Water Use Efficiency. <http://www.cimis.water.ca.gov/cimis/welcome.jsp> (last accessed November 9, 2010)
- DPR, 2008. California Pesticide Use Report – 2008 Summary Data. Available at: [http://www.cdpr.ca.gov/docs/pur/pur08rep/08\\_pur.htm](http://www.cdpr.ca.gov/docs/pur/pur08rep/08_pur.htm). October 29, 2010
- Fan, S., P. Wofford, D. Kim, R. Segawa, H. Feng, and J. Hsu. 2008. Environmental Monitoring Results of Multifumigant Applications in Manteca, California 2005. <http://www.cdpr.ca.gov/docs/emon/pubs/ehapreps/eh0703.pdf>

- Johnson, Bruce. 2001. Evaluating the Effectiveness of Methyl Bromide Soil Buffer Zones in Maintaining Acute Exposures below a Reference Air Concentration. California Environmental Protection Agency, Department of Pesticide Regulation, EH00-10 April 2001. Available at: <http://www.cdpr.ca.gov/docs/emon/pubs/ehapreps/eh0010.pdf>
- Johnson, Bruce, Terrell Barry and Pamela Wofford. 2010. Workbook for Gaussian modeling analysis of air concentration measurements. September 1999, Revised May 2010. State of California Environmental Protection Agency, Department of Pesticide Regulation, Environmental Monitoring Branch. [http://www.cdpr.ca.gov/docs/emon/pubs/ehapreps/analysis\\_memos/4559\\_sanders.pdf](http://www.cdpr.ca.gov/docs/emon/pubs/ehapreps/analysis_memos/4559_sanders.pdf)
- Johnson, Bruce, and Edgar Vidrio. 2011. Part 2: Processing CIMIS meteorological files to produce ISCST3-ready weather files: Technical Manual. July 2011. California Environmental Protection Agency. Department of Pesticide Regulation. Environmental Monitoring Branch . Air Program. P.O. Box 4015 . Sacramento, California 95812-4015
- Menebroker, Raymond. 2000. Memorandum to John Sanders on Review of DPR protocol "Determination of frequency distributions of required buffer zones for daily concentrations of methyl bromide". June 7, 2000.
- Ross, L.J., B. Johnson, K.D. Kim, and J. Hsu. 1996. Prediction of methyl bromide flux from area sources using the ISCST model. J. Environ. Qual. 25:885891.
- USEPA, 1995a. User's guide for the industrial source complex (ISC3) dispersion models. Volume 1 - User Instructions. EPA-454/B-95-003a. U.S. Environmental Protection Agency. Office of Air Quality Planning and Standards Emissions, Monitoring and Analysis Division Research Triangle Park, North Carolina 27711. September 1995.
- USEPA, 1995b. User's guide for the industrial source complex (ISC3) dispersion models. Volume 2 - Description of model algorithms. EPA-454/B-95-003b. U.S. Environmental Protection Agency. Office of Air Quality Planning and Standards Emissions, Monitoring and Analysis Division Research Triangle Park, North Carolina 27711. September 1995
- USEPA, 2000. Meteorological monitoring guidance for regulatory modeling applications. U.S. Environmental Protection Agency, Office of Air and Radiation, Office of Air Quality Planning and Standards, Research Triangle Park, NC 27711 EPA-454/R-99-005 February 2000.

## Appendix 1: Summary of missing days for 90 years of CIMIS meteorological data.

| Data Year | County | Location     | Station No | Latitude           | Longitude             | Elevation (ft) | # of missing days | Missing Days Summary File   | .ISC Data File               |
|-----------|--------|--------------|------------|--------------------|-----------------------|----------------|-------------------|-----------------------------|------------------------------|
| 2005      | Fresno | Fresno State | 80         | 36°49'15"N / 36.82 | 119°44'31"W / -119.74 | 339            | 0                 | <a href="#">C80-05.SUM</a>  | <a href="#">05CIM080.ISC</a> |
| 2006      | Fresno | Fresno State | 80         | 36°49'15"N / 36.82 | 119°44'31"W / -119.74 | 339            | 0                 | <a href="#">C80-06.SUM</a>  | <a href="#">06CIM080.ISC</a> |
| 2007      | Fresno | Fresno State | 80         | 36°49'15"N / 36.82 | 119°44'31"W / -119.74 | 339            | 0                 | <a href="#">C80-07.SUM</a>  | <a href="#">07CIM080.ISC</a> |
| 2008      | Fresno | Fresno State | 80         | 36°49'15"N / 36.82 | 119°44'31"W / -119.74 | 339            | 0                 | <a href="#">C80-08.SUM</a>  | <a href="#">08CIM080.ISC</a> |
| 2009      | Fresno | Fresno State | 80         | 36°49'15"N / 36.82 | 119°44'31"W / -119.74 | 339            | 2                 | <a href="#">C80-09.SUM</a>  | <a href="#">09CIM080.ISC</a> |
| 2005      | Fresno | Westlands    | 105        | 36°38'00"N / 36.63 | 120°22'55"W / -120.38 | 191            | 3                 | <a href="#">C105-05.SUM</a> | <a href="#">05CIM105.ISC</a> |
| 2006      | Fresno | Westlands    | 105        | 36°38'00"N / 36.63 | 120°22'55"W / -120.38 | 191            | 7                 | <a href="#">C105-06.SUM</a> | <a href="#">06CIM105.ISC</a> |
| 2007      | Fresno | Westlands    | 105        | 36°38'00"N / 36.63 | 120°22'55"W / -120.38 | 191            | 0                 | <a href="#">C105-07.SUM</a> | <a href="#">07CIM105.ISC</a> |
| 2008      | Fresno | Westlands    | 105        | 36°38'00"N / 36.63 | 120°22'55"W / -120.38 | 191            | 1                 | <a href="#">C105-08.SUM</a> | <a href="#">08CIM105.ISC</a> |
| 2009      | Fresno | Westlands    | 105        | 36°38'00"N / 36.63 | 120°22'55"W / -120.38 | 191            | 1                 | <a href="#">C105-09.SUM</a> | <a href="#">09CIM105.ISC</a> |
| 2005      | Kern   | Arvin/Edison | 125        | 35°12'22"N / 35.21 | 118°46'40"W / -118.78 | 500            | 12                | <a href="#">C125-05.SUM</a> | <a href="#">05CIM125.ISC</a> |
| 2006      | Kern   | Arvin/Edison | 125        | 35°12'22"N / 35.21 | 118°46'40"W / -118.78 | 500            | 1                 | <a href="#">C125-06.SUM</a> | <a href="#">06CIM125.ISC</a> |
| 2007      | Kern   | Arvin/Edison | 125        | 35°12'22"N / 35.21 | 118°46'40"W / -118.78 | 500            | 0                 | <a href="#">C125-07.SUM</a> | <a href="#">07CIM125.ISC</a> |
| 2008      | Kern   | Arvin/Edison | 125        | 35°12'22"N / 35.21 | 118°46'40"W / -118.78 | 500            | 0                 | <a href="#">C125-08.SUM</a> | <a href="#">08CIM125.ISC</a> |
| 2009      | Kern   | Arvin/Edison | 125        | 35°12'22"N / 35.21 | 118°46'40"W / -118.78 | 500            | 1                 | <a href="#">C125-09.SUM</a> | <a href="#">09CIM125.ISC</a> |
| 2005      | Kern   | Belridge     | 146        | 35°30'19"N / 35.51 | 119°41'23"W / -119.69 | 410            | 0                 | <a href="#">C146-05.SUM</a> | <a href="#">05CIM146.ISC</a> |
| 2006      | Kern   | Belridge     | 146        | 35°30'19"N / 35.51 | 119°41'23"W / -119.69 | 410            | 0                 | <a href="#">C146-06.SUM</a> | <a href="#">06CIM146.ISC</a> |
| 2007      | Kern   | Belridge     | 146        | 35°30'19"N / 35.51 | 119°41'23"W / -119.69 | 410            | 0                 | <a href="#">C146-07.SUM</a> | <a href="#">07CIM146.ISC</a> |
| 2008      | Kern   | Belridge     | 146        | 35°30'19"N / 35.51 | 119°41'23"W / -119.69 | 410            | 0                 | <a href="#">C146-08.SUM</a> | <a href="#">08CIM146.ISC</a> |
| 2009      | Kern   | Belridge     | 146        | 35°30'19"N / 35.51 | 119°41'23"W / -119.69 | 410            | 1                 | <a href="#">C146-09.SUM</a> | <a href="#">09CIM146.ISC</a> |
| 2005      | Kings  | Kettleman    | 21         | 35°52'08"N / 35.87 | 119°53'39"W / -119.89 | 340            | 0                 | <a href="#">C21-05.SUM</a>  | <a href="#">05CIM021.ISC</a> |
| 2006      | Kings  | Kettleman    | 21         | 35°52'08"N / 35.87 | 119°53'39"W / -119.89 | 340            | 0                 | <a href="#">C21-06.SUM</a>  | <a href="#">06CIM021.ISC</a> |

|      |          |                 |     |                    |                       |     |    |                             |                              |
|------|----------|-----------------|-----|--------------------|-----------------------|-----|----|-----------------------------|------------------------------|
| 2007 | Kings    | Kettleman       | 21  | 35°52'08"N / 35.87 | 119°53'39"W / -119.89 | 340 | 0  | <a href="#">C21-07.SUM</a>  | <a href="#">07CIM021.ISC</a> |
| 2008 | Kings    | Kettleman       | 21  | 35°52'08"N / 35.87 | 119°53'39"W / -119.89 | 340 | 2  | <a href="#">C21-08.SUM</a>  | <a href="#">08CIM021.ISC</a> |
| 2009 | Kings    | Kettleman       | 21  | 35°52'08"N / 35.87 | 119°53'39"W / -119.89 | 340 | 1  | <a href="#">C21-09.SUM</a>  | <a href="#">09CIM021.ISC</a> |
| 2005 | Kings    | Stratford       | 15  | 36°09'27"N / 36.16 | 119°51'00"W / -119.85 | 193 | 0  | <a href="#">C15-05.SUM</a>  | <a href="#">05CIM015.ISC</a> |
| 2006 | Kings    | Stratford       | 15  | 36°09'27"N / 36.16 | 119°51'00"W / -119.85 | 193 | 0  | <a href="#">C15-06.SUM</a>  | <a href="#">06CIM015.ISC</a> |
| 2007 | Kings    | Stratford       | 15  | 36°09'27"N / 36.16 | 119°51'00"W / -119.85 | 193 | 6  | <a href="#">C15-07.SUM</a>  | <a href="#">07CIM015.ISC</a> |
| 2008 | Kings    | Stratford       | 15  | 36°09'27"N / 36.16 | 119°51'00"W / -119.85 | 193 | 15 | <a href="#">C15-08.SUM</a>  | <a href="#">08CIM015.ISC</a> |
| 2009 | Kings    | Stratford       | 15  | 36°09'27"N / 36.16 | 119°51'00"W / -119.85 | 193 | 1  | <a href="#">C15-09.SUM</a>  | <a href="#">09CIM015.ISC</a> |
| 2005 | Madera   | Madera          | 145 | 37°01'04"N / 37.02 | 120°11'12"W / -120.19 | 230 | 25 | <a href="#">C145-05.SUM</a> | <a href="#">05CIM145.ISC</a> |
| 2006 | Madera   | Madera          | 145 | 37°01'04"N / 37.02 | 120°11'12"W / -120.19 | 230 | 11 | <a href="#">C145-06.SUM</a> | <a href="#">06CIM145.ISC</a> |
| 2007 | Madera   | Madera          | 145 | 37°01'04"N / 37.02 | 120°11'12"W / -120.19 | 230 | 3  | <a href="#">C145-07.SUM</a> | <a href="#">07CIM145.ISC</a> |
| 2008 | Madera   | Madera          | 145 | 37°01'04"N / 37.02 | 120°11'12"W / -120.19 | 230 | 0  | <a href="#">C145-08.SUM</a> | <a href="#">08CIM145.ISC</a> |
| 2009 | Madera   | Madera          | 145 | 37°01'04"N / 37.02 | 120°11'12"W / -120.19 | 230 | 4  | <a href="#">C145-09.SUM</a> | <a href="#">09CIM145.ISC</a> |
| 2005 | Merced   | Los Banos       | 56  | 37°05'36"N / 37.09 | 120°45'39"W / -120.76 | 95  | 0  | <a href="#">C56-05.SUM</a>  | <a href="#">05CIM056.ISC</a> |
| 2006 | Merced   | Los Banos       | 56  | 37°05'36"N / 37.09 | 120°45'39"W / -120.76 | 95  | 2  | <a href="#">C56-06.SUM</a>  | <a href="#">06CIM056.ISC</a> |
| 2007 | Merced   | Los Banos       | 56  | 37°05'36"N / 37.09 | 120°45'39"W / -120.76 | 95  | 5  | <a href="#">C56-07.SUM</a>  | <a href="#">07CIM056.ISC</a> |
| 2008 | Merced   | Los Banos       | 56  | 37°05'36"N / 37.09 | 120°45'39"W / -120.76 | 95  | 14 | <a href="#">C56-08.SUM</a>  | <a href="#">08CIM056.ISC</a> |
| 2009 | Merced   | Los Banos       | 56  | 37°05'36"N / 37.09 | 120°45'39"W / -120.76 | 95  | 4  | <a href="#">C56-09.SUM</a>  | <a href="#">09CIM056.ISC</a> |
| 2005 | Merced   | Merced          | 148 | 37°18'49"N / 37.31 | 120°23'11"W / -120.39 | 200 | 18 | <a href="#">C148-05.SUM</a> | <a href="#">05CIM148.ISC</a> |
| 2006 | Merced   | Merced          | 148 | 37°18'49"N / 37.31 | 120°23'11"W / -120.39 | 200 | 8  | <a href="#">C148-06.SUM</a> | <a href="#">06CIM148.ISC</a> |
| 2007 | Merced   | Merced          | 148 | 37°18'49"N / 37.31 | 120°23'11"W / -120.39 | 200 | 0  | <a href="#">C148-07.SUM</a> | <a href="#">07CIM148.ISC</a> |
| 2008 | Merced   | Merced          | 148 | 37°18'49"N / 37.31 | 120°23'11"W / -120.39 | 200 | 0  | <a href="#">C148-08.SUM</a> | <a href="#">08CIM148.ISC</a> |
| 2009 | Merced   | Merced          | 148 | 37°18'49"N / 37.31 | 120°23'11"W / -120.39 | 200 | 1  | <a href="#">C148-09.SUM</a> | <a href="#">09CIM148.ISC</a> |
| 2005 | Monterey | King City-Oasis | 113 | 36°07'17"N / 36.12 | 121°05'02"W / -121.08 | 540 | 0  | <a href="#">C113-05.SUM</a> | <a href="#">05CIM113.ISC</a> |
| 2006 | Monterey | King City-Oasis | 113 | 36°07'17"N / 36.12 | 121°05'02"W / -121.08 | 540 | 2  | <a href="#">C113-06.SUM</a> | <a href="#">06CIM113.ISC</a> |

|      |             |                 |     |                    |                       |     |    |                             |                              |
|------|-------------|-----------------|-----|--------------------|-----------------------|-----|----|-----------------------------|------------------------------|
| 2007 | Monterey    | King City-Oasis | 113 | 36°07'17"N / 36.12 | 121°05'02"W / -121.08 | 540 | 0  | <a href="#">C113-07.SUM</a> | <a href="#">07CIM113.ISC</a> |
| 2008 | Monterey    | King City-Oasis | 113 | 36°07'17"N / 36.12 | 121°05'02"W / -121.08 | 540 | 0  | <a href="#">C113-08.SUM</a> | <a href="#">08CIM113.ISC</a> |
| 2009 | Monterey    | King City-Oasis | 113 | 36°07'17"N / 36.12 | 121°05'02"W / -121.08 | 540 | 1  | <a href="#">C113-09.SUM</a> | <a href="#">09CIM113.ISC</a> |
| 2005 | Monterey    | Salinas         | 89  | 36°36'36"N / 36.61 | 121°31'46"W / -121.53 | 120 | 0  | <a href="#">C89-05.SUM</a>  | <a href="#">05CIM089.ISC</a> |
| 2006 | Monterey    | Salinas         | 89  | 36°36'36"N / 36.61 | 121°31'46"W / -121.53 | 120 | 0  | <a href="#">C89-06.SUM</a>  | <a href="#">06CIM089.ISC</a> |
| 2007 | Monterey    | Salinas         | 89  | 36°36'36"N / 36.61 | 121°31'46"W / -121.53 | 120 | 0  | <a href="#">C89-07.SUM</a>  | <a href="#">07CIM089.ISC</a> |
| 2008 | Monterey    | Salinas         | 89  | 36°36'36"N / 36.61 | 121°31'46"W / -121.53 | 120 | 6  | <a href="#">C89-08.SUM</a>  | <a href="#">08CIM089.ISC</a> |
| 2009 | Monterey    | Salinas         | 89  | 36°36'36"N / 36.61 | 121°31'46"W / -121.53 | 120 | 16 | <a href="#">C89-09.SUM</a>  | <a href="#">09CIM089.ISC</a> |
| 2005 | San Joaquin | Lodi West       | 166 | 38°07'48"N / 38.13 | 121°22'57"W / -121.38 | 25  | 0  | <a href="#">C166-05.SUM</a> | <a href="#">05CIM166.ISC</a> |
| 2006 | San Joaquin | Lodi West       | 166 | 38°07'48"N / 38.13 | 121°22'57"W / -121.38 | 25  | 4  | <a href="#">C166-06.SUM</a> | <a href="#">06CIM166.ISC</a> |
| 2007 | San Joaquin | Lodi West       | 166 | 38°07'48"N / 38.13 | 121°22'57"W / -121.38 | 25  | 0  | <a href="#">C166-07.SUM</a> | <a href="#">07CIM166.ISC</a> |
| 2008 | San Joaquin | Lodi West       | 166 | 38°07'48"N / 38.13 | 121°22'57"W / -121.38 | 25  | 5  | <a href="#">C166-08.SUM</a> | <a href="#">08CIM166.ISC</a> |
| 2009 | San Joaquin | Lodi West       | 166 | 38°07'48"N / 38.13 | 121°22'57"W / -121.38 | 25  | 38 | <a href="#">C166-09.SUM</a> | <a href="#">09CIM166.ISC</a> |
| 2005 | San Joaquin | Manteca         | 70  | 37°50'05"N / 37.84 | 121°13'22"W / -121.22 | 33  | 0  | <a href="#">C70-05.SUM</a>  | <a href="#">05CIM070.ISC</a> |
| 2006 | San Joaquin | Manteca         | 70  | 37°50'05"N / 37.84 | 121°13'22"W / -121.22 | 33  | 1  | <a href="#">C70-06.SUM</a>  | <a href="#">06CIM070.ISC</a> |
| 2007 | San Joaquin | Manteca         | 70  | 37°50'05"N / 37.84 | 121°13'22"W / -121.22 | 33  | 0  | <a href="#">C70-07.SUM</a>  | <a href="#">07CIM070.ISC</a> |
| 2008 | San Joaquin | Manteca         | 70  | 37°50'05"N / 37.84 | 121°13'22"W / -121.22 | 33  | 0  | <a href="#">C70-08.SUM</a>  | <a href="#">08CIM070.ISC</a> |
| 2009 | San Joaquin | Manteca         | 70  | 37°50'05"N / 37.84 | 121°13'22"W / -121.22 | 33  | 1  | <a href="#">C70-09.SUM</a>  | <a href="#">09CIM070.ISC</a> |
| 2005 | Stanislaus  | Oakdale         | 194 | 37°43'07"N / 37.72 | 120°51'03"W / -120.85 | 165 | 0  | <a href="#">C194-05.SUM</a> | <a href="#">05CIM194.ISC</a> |
| 2006 | Stanislaus  | Oakdale         | 194 | 37°43'07"N / 37.72 | 120°51'03"W / -120.85 | 165 | 9  | <a href="#">C194-06.SUM</a> | <a href="#">06CIM194.ISC</a> |
| 2007 | Stanislaus  | Oakdale         | 194 | 37°43'07"N / 37.72 | 120°51'03"W / -120.85 | 165 | 0  | <a href="#">C194-07.SUM</a> | <a href="#">07CIM194.ISC</a> |
| 2008 | Stanislaus  | Oakdale         | 194 | 37°43'07"N / 37.72 | 120°51'03"W / -120.85 | 165 | 4  | <a href="#">C194-08.SUM</a> | <a href="#">08CIM194.ISC</a> |
| 2009 | Stanislaus  | Oakdale         | 194 | 37°43'07"N / 37.72 | 120°51'03"W / -120.85 | 165 | 1  | <a href="#">C194-09.SUM</a> | <a href="#">09CIM194.ISC</a> |
| 2005 | Stanislaus  | Patterson       | 161 | 37°26'24"N / 37.44 | 121°08'20"W / -121.14 | 183 | 0  | <a href="#">C161-05.SUM</a> | <a href="#">05CIM161.ISC</a> |
| 2006 | Stanislaus  | Patterson       | 161 | 37°26'24"N / 37.44 | 121°08'20"W / -121.14 | 183 | 4  | <a href="#">C161-06.SUM</a> | <a href="#">06CIM161.ISC</a> |

|      |            |           |     |                    |                       |     |    |                             |                              |
|------|------------|-----------|-----|--------------------|-----------------------|-----|----|-----------------------------|------------------------------|
| 2007 | Stanislaus | Patterson | 161 | 37°26'24"N / 37.44 | 121°08'20"W / -121.14 | 183 | 0  | <a href="#">C161-07.SUM</a> | <a href="#">07CIM161.ISC</a> |
| 2008 | Stanislaus | Patterson | 161 | 37°26'24"N / 37.44 | 121°08'20"W / -121.14 | 183 | 0  | <a href="#">C161-08.SUM</a> | <a href="#">08CIM161.ISC</a> |
| 2009 | Stanislaus | Patterson | 161 | 37°26'24"N / 37.44 | 121°08'20"W / -121.14 | 183 | 1  | <a href="#">C161-09.SUM</a> | <a href="#">09CIM161.ISC</a> |
| 2005 | Tulare     | Delano    | 182 | 35°49'59"n / 35.83 | 119°15'21"w / -119.26 | 300 | 4  | <a href="#">C182-05.SUM</a> | <a href="#">05CIM182.ISC</a> |
| 2006 | Tulare     | Delano    | 182 | 35°49'59"n / 35.83 | 119°15'21"w / -119.26 | 300 | 3  | <a href="#">C182-06.SUM</a> | <a href="#">06CIM182.ISC</a> |
| 2007 | Tulare     | Delano    | 182 | 35°49'59"n / 35.83 | 119°15'21"w / -119.26 | 300 | 16 | <a href="#">C182-07.SUM</a> | <a href="#">07CIM182.ISC</a> |
| 2008 | Tulare     | Delano    | 182 | 35°49'59"n / 35.83 | 119°15'21"w / -119.26 | 300 | 0  | <a href="#">C182-08.SUM</a> | <a href="#">08CIM182.ISC</a> |
| 2009 | Tulare     | Delano    | 182 | 35°49'59"n / 35.83 | 119°15'21"w / -119.26 | 300 | 61 | <a href="#">C182-09.SUM</a> | <a href="#">09CIM182.ISC</a> |
| 2005 | Tulare     | Lindcove  | 86  | 36°21'26"N / 36.36 | 119°03'31"W / -119.06 | 480 | 5  | <a href="#">C86-05.SUM</a>  | <a href="#">05CIM086.ISC</a> |
| 2006 | Tulare     | Lindcove  | 86  | 36°21'26"N / 36.36 | 119°03'31"W / -119.06 | 480 | 17 | <a href="#">C86-06.SUM</a>  | <a href="#">06CIM086.ISC</a> |
| 2007 | Tulare     | Lindcove  | 86  | 36°21'26"N / 36.36 | 119°03'31"W / -119.06 | 480 | 0  | <a href="#">C86-07.SUM</a>  | <a href="#">07CIM086.ISC</a> |
| 2008 | Tulare     | Lindcove  | 86  | 36°21'26"N / 36.36 | 119°03'31"W / -119.06 | 480 | 39 | <a href="#">C86-08.SUM</a>  | <a href="#">08CIM086.ISC</a> |
| 2009 | Tulare     | Lindcove  | 86  | 36°21'26"N / 36.36 | 119°03'31"W / -119.06 | 480 | 1  | <a href="#">C86-09.SUM</a>  | <a href="#">09CIM086.ISC</a> |
| 2005 | Ventura    | Oxnard    | 156 | 34°14'01"n / 34.23 | 119°11'49"w / -119.2  | 48  | 1  | <a href="#">C156-05.SUM</a> | <a href="#">05CIM156.ISC</a> |
| 2006 | Ventura    | Oxnard    | 156 | 34°14'01"n / 34.23 | 119°11'49"w / -119.2  | 48  | 0  | <a href="#">C156-06.SUM</a> | <a href="#">06CIM156.ISC</a> |
| 2007 | Ventura    | Oxnard    | 156 | 34°14'01"n / 34.23 | 119°11'49"w / -119.2  | 48  | 0  | <a href="#">C156-07.SUM</a> | <a href="#">07CIM156.ISC</a> |
| 2008 | Ventura    | Oxnard    | 156 | 34°14'01"n / 34.23 | 119°11'49"w / -119.2  | 48  | 1  | <a href="#">C156-08.SUM</a> | <a href="#">08CIM156.ISC</a> |
| 2009 | Ventura    | Oxnard    | 156 | 34°14'01"n / 34.23 | 119°11'49"w / -119.2  | 48  | 0  | <a href="#">C156-09.SUM</a> | <a href="#">09CIM156.ISC</a> |



## Appendix 2: Recommended procedures and tutorial processing for yearly CIMIS data sets into .ISC files

(Note: SS → Station ID Number; YY → Year)

- 1) In Windows Explorer, create a directory to process CIMIS files.
- 2) Copy the 6 programs that will be needed to process CIMIS data (PROCSVV02, FIXDASHV2, PREFORMV2, CIMPRO1V4, CIMPRO2V5, and MAKISCV2) from Air\_Emergency\_Proj:\CIMIS-met-process\programs(BJohnson) to the newly created directory.
- 3) Using a web browser, navigate to the website: <http://wwwcimis.water.ca.gov/>
  - a. Click on **Register** and register for full access to the site and data. If already registered, log onto the site.
  - b. Click on the **“DATA”** tab (Appendix 2 Figure 1).
  - c. Under **“Select report style and date range:”** select an hourly, CSV report, Metric Units, and the desired start and end dates.



Appendix 2 Figure 1. CIMIS website station data screen.

- d. Select the desired CIMIS Data Station from the station list box
- e. Check the **“Select Sensors”** box in the optional **“Advanced settings”** area below the station list.
- f. Choose all of the following sensors from the **“Sensor”** list box
  1. Precipitation
  2. Solar Radiation
  3. Net Radiation
  4. Air Temperature
  5. Wind Speed
  6. Wind Direction
  7. Std Dev of Wind Direction
- g. Click on **Run Report** and download the file to your hard drive. Consider renaming the saved file and future files in a consistent and logical fashion (such as Station# - County –Location – Date Range).

- 4) Navigate to location of saved CIMIS file and right-click on selected file, select **Open with**, then select **Notepad** (Appendix 2 Figure 2).
  - a. Once file is opened in Notepad, click **File**, click **Save As...** rename the file using the following name format: **CSS-YY.UXT** (“C” followed by station number “-” followed by year(s)).
  - b. Under **Save as type**, select **All Files**
  - c. Save it to the directory created in Step 1.

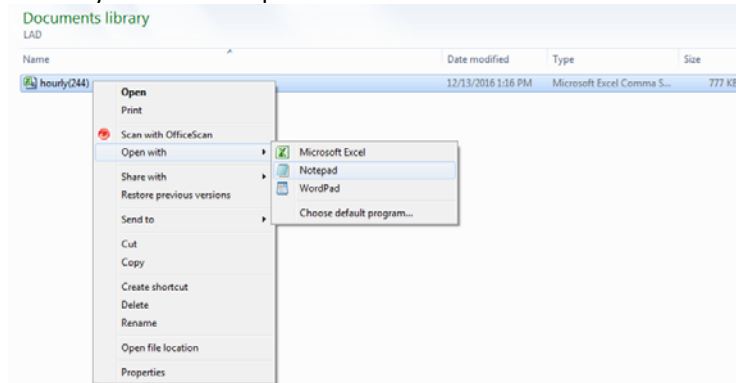

**Appendix 2 Figure 2.** Opening of downloaded CIMIS hourly data using Microsoft Notepad.

- 5) Open DOS Command Prompt window by clicking **Start**, point to **Programs**, point to **Accessories**, and click **Command Prompt**.
- 6) Select the folder directory where the input files are located and where the output data files will be saved by using the following common DOS Commands, depending on where the data files are to be stored:

Sample DOS commands (taken from Johnson et al, 2010):

- **CD..** moves up one directory level
- **CD 'subdirectory'** moves down one level to subdirectory
- **DIR** lists the current directory contents
- **DIR \*.out** lists all of the files with the 'out' extension
- **TREE** shows the current and subdirectory structure
- **DEL 'filename'** deletes the file called filename
- **COPY 'filename1 filename2'** makes a copy of filename1
- **NOTEPAD 'filename'** runs the NOTEPAD text editor on filename
- **MKDIR 'subdirectory'** creates a subdirectory
- **RENAME filename1 filename2** renames filename1 into filename 2

Example DOS command: **"cd C:\Users\ccollins\Documents"** takes user\* to My Documents folder.

\*User is unique to each log in ID. User ID in this example was "ccollins." In the figures below, you'll see the following directory was used: C:\Users\ccollins\Documents\Data\CIMIS\Workbench.

- 7) Type **"PROCSVV02 CSS-YY.UXT CSS-YY.DXT"** and Press ENTER
- 8) Type **"FIXDASHV2 CSS-YY.DXT CSS-YY.TXT"** and Press ENTER
  - a. Note: The program removes the dashes inserted by CIMIS programs whenever missing values are present. The program also arranges the date in the right format for the next step.

```

Administrator: Command Prompt
Microsoft Windows [Version 6.1.7601]
Copyright (c) 2009 Microsoft Corporation. All rights reserved.

H:\>C:

C:\>cd C:\Users\ccollins\Documents\Data\CIMIS\Workbench
C:\Users\ccollins\Documents\Data\CIMIS\Workbench>PROCSUU02 C005-2015.UXT C005-2015.DXT

PROGRAM STOPS - NO COMMAS IN LAST LINE READ
THIS MAY BE OK. FILE MAY HAVE BLANK LINE AT END
LAST PROCESSED OUTPUT LINE WAS
0005.12/31/2015.2400.365.* 0.* -69.* 30.0.* 1.3.* 99.0.* 66.0
.* 0.00
TOTAL RECORDS PROCESSED WERE 8760
CHECK OUTPUT FILE TO VERIFY THAT
INTENDED RECORDS ARE THERE.

C:\Users\ccollins\Documents\Data\CIMIS\Workbench>FIXDASHU2 C005-2015.DXT C005-2015.TXT
C005-2015.DXT C005-2015.TXT LINES= 8760 MISSING= 3

C:\Users\ccollins\Documents\Data\CIMIS\Workbench>

```

Appendix 2 Figure 3. Screenshot of FIXDASHV2 output message

9) Run PREFORMV2

- a. Type “PREFORMV2 CSS-YY.TXT CSS-YY.PRE” and Press ENTER

```

Administrator: Command Prompt
Microsoft Windows [Version 6.1.7601]
Copyright (c) 2009 Microsoft Corporation. All rights reserved.

H:\>C:

C:\>cd C:\Users\ccollins\Documents\Data\CIMIS\Workbench
C:\Users\ccollins\Documents\Data\CIMIS\Workbench>PROCSUU02 C005-2015.UXT C005-2015.DXT

PROGRAM STOPS - NO COMMAS IN LAST LINE READ
THIS MAY BE OK. FILE MAY HAVE BLANK LINE AT END
LAST PROCESSED OUTPUT LINE WAS
0005.12/31/2015.2400.365.* 0.* -69.* 30.0.* 1.3.* 99.0.* 66.0
.* 0.00
TOTAL RECORDS PROCESSED WERE 8760
CHECK OUTPUT FILE TO VERIFY THAT
INTENDED RECORDS ARE THERE.

C:\Users\ccollins\Documents\Data\CIMIS\Workbench>FIXDASHU2 C005-2015.DXT C005-2015.TXT
C005-2015.DXT C005-2015.TXT LINES= 8760 MISSING= 3

C:\Users\ccollins\Documents\Data\CIMIS\Workbench>PREFORMV2 C005-2015.TXT C005-2015.PRE
EOF ON 8760 PROGRAM TERMINATED NORMALY

C:\Users\ccollins\Documents\Data\CIMIS\Workbench>

```

Appendix 2 Figure 4. Screenshot of PREFORMV2 input information and end message stating that program terminated normally.

10) Run CIMPRO1V4

- a. Type “CIMPRO1V4 CSS-YY.PRE CSS-YY.DET” and Press ENTER

b. Notes:

- a) The program produces a \*.SUM file which lists missing values and unusable days and produces a \*.DET file which becomes input for the next process. The \*.SUM file should be examined before going to the next step. To open the \*.SUM file, locate it with Windows Explorer and right-click on the file. Choose “Edit.”
- b) Infrequently, other types of information and error messages may be listed in the \*.SUM file.
- c) The \*.SUM file is for information purposes and can be deleted at the discretion of the user since this file will not be needed for further processing.

```

Administrator: Command Prompt
Microsoft Windows [Version 6.1.7601]
Copyright (c) 2009 Microsoft Corporation. All rights reserved.

H:\>C:
C:\>cd C:\Users\ccollins\Documents\Data\CIMIS\Workbench
C:\Users\ccollins\Documents\Data\CIMIS\Workbench>PROCSU02 C005-2015.UXT C005-2015.DWT

PROGRAM STOPS - NO COMMAS IN LAST LINE READ
THIS MAY BE OK, FILE MAY HAVE BLANK LINE AT END
LAST PROCESSED OUTPUT LINE WAS
0005.12/31/2015.2400.365.* 0.* -69.* 30.0.* 1.3.* 99.0.* 66.0
.* 0.00
TOTAL RECORDS PROCESSED WERE 8760
CHECK OUTPUT FILE TO VERIFY THAT
INTENDED RECORDS ARE THERE.
C:\Users\ccollins\Documents\Data\CIMIS\Workbench>FIXDASHU2 C005-2015.DWT C005-2015.TXT
C005-2015.DXT C005-2015.TXT LINES= 8760 MISSING= 3
C:\Users\ccollins\Documents\Data\CIMIS\Workbench>PREFORMU2 C005-2015.TXT C005-2015.PRE
EOF ON 8760 PROGRAM TERMINATED NORMALY
C:\Users\ccollins\Documents\Data\CIMIS\Workbench>CIMPRO1U4 C005-2015.PRE C005-2015.DET

ONLY DAYS WITH BAD OR MISSING VALUES ARE LISTED.
AN * ON LEFT INDICATES THAT ALL 24H ARE BAD FOR THAT SENSOR.
AM * ON RIGHT INDICATES THAT DAY WILL BE MARKED UNUSABLE.

RECORD DAY SENSOR HOURLY FLAG : GOOD/BAD
-----
888 37 AIRTEMP G G G G G G G G G G B B B G G G G G G G G G G G 3
CRITERIA FOR REJECTING DAYS: WHEN > 4 RECORDS ARE BAD FOR AT LEAST 1 VARIABLE
8760 RECORDS EXAMINED WHICH IS 365 DAYS
GOOD DAYS= 365, BAD DAYS= 0, SUM OF BOTH= 365
R WAS NOT CONSIDERED AS BAD DATA IN THIS RUN
C:\Users\ccollins\Documents\Data\CIMIS\Workbench>

```

Appendix 2 Figure 5. Screenshot of CIMPRO1V4 program run sequence and output message.

11) Run CIMPRO2V5

- a. Type “CIMPRO2V5 CSS-YY.DET YYCIMSS.2PC” and Press ENTER

Note: The program processes the \*.DET file and produces a file where the first part of each record is from the \*.DET file, and the ISC part of the record is appended on the end of each record.

12) Run MAKISCV2

- a. Type “MAKISCV2 YYCIMSSS.2PC YYCIMSSS.ISC” and Press ENTER

Note: The program grabs the last portion of each record from above and produces a continuous ISC file *for the usable days*. (An unusable day is currently defined as any day with more than 4 consecutive hours missing or bad data. Runs of 4 hours or less are interpolated. Days which were unusable are omitted from the file.)

```

Administrator: Command Prompt

RECORD DAY SENSOR HOURLY FLAG : GOOD/BAD
-----
888 37 AIRTEMP G G G G G G G G G G B B B G G G G G G G G G G G 3
CRITERIA FOR REJECTING DAYS: WHEN > 4 RECORDS ARE BAD FOR AT LEAST 1 VARIABLE
8760 RECORDS EXAMINED WHICH IS 365 DAYS
GOOD DAYS= 365, BAD DAYS= 0, SUM OF BOTH= 365
R WAS NOT CONSIDERED AS BAD DATA IN THIS RUN
C:\Users\ccollins\Documents\Data\CIMIS\Workbench>CIMPRO2U5 C005-2015.DET 15CIM005.2PC
C:\Users\ccollins\Documents\Data\CIMIS\Workbench>MAKISCV2 15CIM005.2PC 15CIM005.ISC
NORMAL TERMINATION
C:\Users\ccollins\Documents\Data\CIMIS\Workbench>

```

Appendix 2 Figure 6. Screenshot of MAKISCV2 program output.

### Appendix 3: Recommended procedures and tutorial to create Wind Rose graphs from .ISC files

Note: This tutorial is set up to create wind roses using WRPLOT View™ by Lakes Environmental™. If WRPLOT View™ is not already installed on your computer, visit <https://www.weblakes.com/products/wrplot/index.html> to register for a free copy.

- 1) With WRPLOT View™ open, click on **Add File**.
- 2) In the directory window, navigate to the folder with the processed CIMIS files and change **Files of type** to **All Files (\*.\*)**.

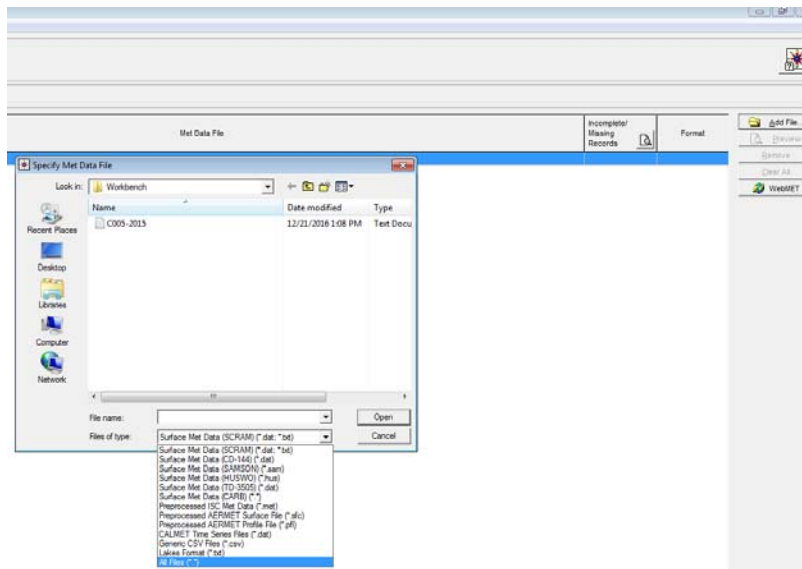

Appendix 3 Figure 1. Importing weather data into WRPLOT View™.

- 3) Select the desired file which should be classified as **ISC File** under “Type” and click on **Open**.

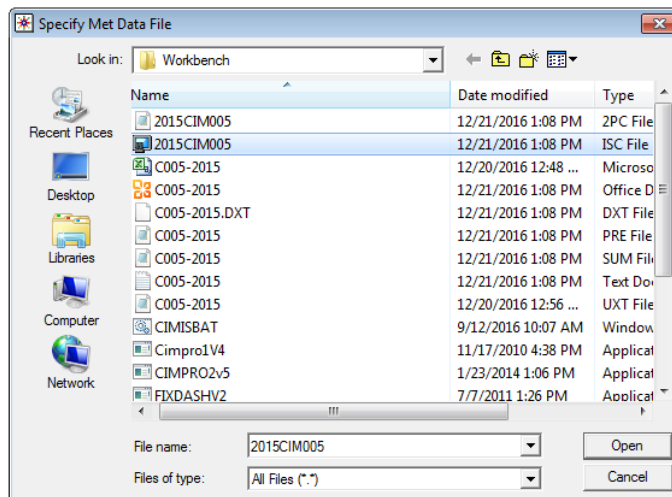

Appendix 3 Figure 2. Selecting the ISC File.

- 4) Near the top of the program, select the following:
  - a. **Display** = Wind Speed
  - b. **Wind Directions** = 16
  - c. **Units** = m/s
  - d. **Orientation** = Direction (blowing from)

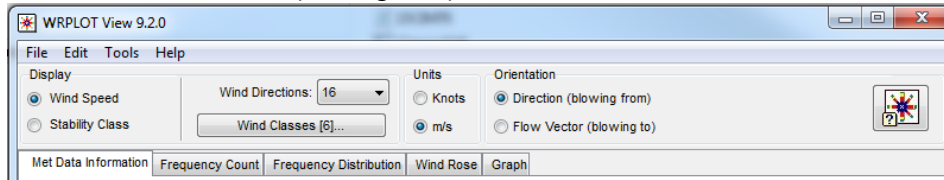

**Appendix 3 Figure 3.** Selecting the proper options to create the desired Wind Rose.

- 5) Click on the tab labeled **Wind Rose** to view a graphical display of wind direction and speed from the processed CIMIS data.

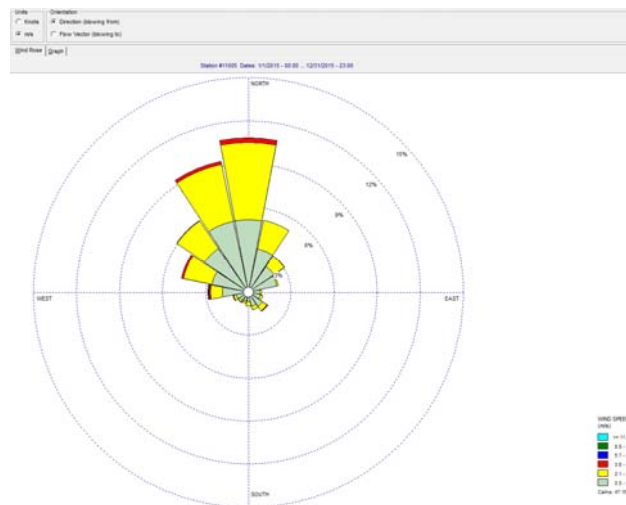

**Appendix 3 Figure 4.** Generating a wind rose with WRPLOT View™ from processed CIMIS data.

- 6) To export the newly created Wind Rose, click **Edit** → **Copy to File** → **Bitmap...**

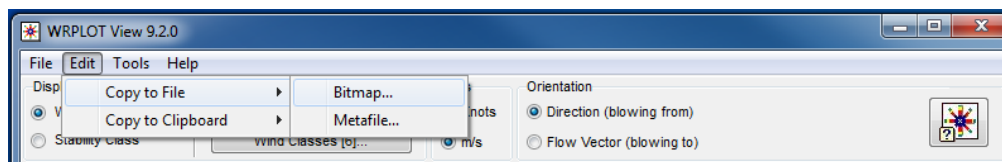

**Appendix 3 Figure 5.** Saving Wind Rose as a Bitmap file.

- 7) Save the bitmap file with an 8-digit naming convention that follows a consistent and logical fashion, such as year-data source - station number (e.g., 15CIM088).

#### Appendix 4: Manual versus CIMPRO2V3 determined stability classifications

| Number | File Name    | Date       | Hour | Manually Calculated Stability | CIMPRO2V3 Calculated Stability |
|--------|--------------|------------|------|-------------------------------|--------------------------------|
| 1      | 08CIM194.2P0 | 2/21/2008  | 1    | 5                             | 5                              |
| 2      | 08CIM194.2P0 | 2/21/2008  | 2    | 4                             | 4                              |
| 3      | 08CIM194.2P0 | 2/21/2008  | 3    | 4                             | 4                              |
| 4      | 08CIM194.2P0 | 2/21/2008  | 4    | 5                             | 5                              |
| 5      | 08CIM194.2P0 | 2/21/2008  | 5    | 5                             | 5                              |
| 6      | 08CIM194.2P0 | 2/21/2008  | 6    | 4                             | 4                              |
| 7      | 08CIM194.2P0 | 2/21/2008  | 7    | 5                             | 5                              |
| 8      | 08CIM194.2P0 | 2/21/2008  | 8    | 4                             | 4                              |
| 9      | 08CIM194.2P0 | 2/21/2008  | 9    | 3                             | 3                              |
| 10     | 08CIM194.2P0 | 2/21/2008  | 10   | 4                             | 4                              |
| 11     | 08CIM194.2P0 | 2/21/2008  | 11   | 4                             | 4                              |
| 12     | 08CIM194.2P0 | 2/21/2008  | 12   | 4                             | 4                              |
| 13     | 08CIM194.2P0 | 2/21/2008  | 13   | 4                             | 4                              |
| 14     | 08CIM194.2P0 | 2/21/2008  | 14   | 4                             | 4                              |
| 15     | 08CIM194.2P0 | 2/21/2008  | 15   | 4                             | 4                              |
| 16     | 08CIM194.2P0 | 2/21/2008  | 16   | 4                             | 4                              |
| 17     | 08CIM194.2P0 | 2/21/2008  | 17   | 4                             | 4                              |
| 18     | 08CIM194.2P0 | 2/21/2008  | 18   | 5                             | 5                              |
| 19     | 08CIM194.2P0 | 2/21/2008  | 19   | 4                             | 4                              |
| 20     | 08CIM194.2P0 | 2/21/2008  | 20   | 4                             | 4                              |
| 21     | 08CIM194.2P0 | 2/21/2008  | 21   | 4                             | 4                              |
| 22     | 08CIM194.2P0 | 2/21/2008  | 22   | 4                             | 4                              |
| 23     | 08CIM194.2P0 | 2/21/2008  | 23   | 5                             | 5                              |
| 24     | 08CIM194.2P0 | 2/21/2008  | 24   | 6                             | 6                              |
| 25     | 06CIM145.2P0 | 10/23/2006 | 1    | 5                             | 5                              |
| 26     | 06CIM145.2P0 | 10/23/2006 | 2    | 6                             | 6                              |
| 27     | 06CIM145.2P0 | 10/23/2006 | 3    | 6                             | 6                              |
| 28     | 06CIM145.2P0 | 10/23/2006 | 4    | 6                             | 6                              |
| 29     | 06CIM145.2P0 | 10/23/2006 | 5    | 6                             | 6                              |
| 30     | 06CIM145.2P0 | 10/23/2006 | 6    | 6                             | 6                              |
| 31     | 06CIM145.2P0 | 10/23/2006 | 7    | 6                             | 6                              |
| 32     | 06CIM145.2P0 | 10/23/2006 | 8    | 5                             | 5                              |
| 33     | 06CIM145.2P0 | 10/23/2006 | 9    | 4                             | 4                              |
| 34     | 06CIM145.2P0 | 10/23/2006 | 10   | 3                             | 3                              |
| 35     | 06CIM145.2P0 | 10/23/2006 | 11   | 2                             | 2                              |
| 36     | 06CIM145.2P0 | 10/23/2006 | 12   | 1                             | 1                              |
| 37     | 06CIM145.2P0 | 10/23/2006 | 13   | 1                             | 1                              |
| 38     | 06CIM145.2P0 | 10/23/2006 | 14   | 1                             | 1                              |
| 39     | 06CIM145.2P0 | 10/23/2006 | 15   | 1                             | 1                              |
| 40     | 06CIM145.2P0 | 10/23/2006 | 16   | 1                             | 1                              |
| 41     | 06CIM145.2P0 | 10/23/2006 | 17   | 1                             | 1                              |
| 42     | 06CIM145.2P0 | 10/23/2006 | 18   | 2                             | 2                              |
| 43     | 06CIM145.2P0 | 10/23/2006 | 19   | 3                             | 3                              |
| 44     | 06CIM145.2P0 | 10/23/2006 | 20   | 4                             | 4                              |
| 45     | 06CIM145.2P0 | 10/23/2006 | 21   | 5                             | 5                              |
| 46     | 06CIM145.2P0 | 10/23/2006 | 22   | 6                             | 6                              |

|    |              |            |    |   |   |
|----|--------------|------------|----|---|---|
| 47 | 06CIM145.2P0 | 10/23/2006 | 23 | 6 | 6 |
| 48 | 06CIM145.2P0 | 10/23/2006 | 24 | 6 | 6 |
| 49 | 08CIM182.2P0 | 9/28/2008  | 1  | 5 | 5 |
| 50 | 08CIM182.2P0 | 9/28/2008  | 2  | 4 | 4 |
| 51 | 08CIM182.2P0 | 9/28/2008  | 3  | 4 | 4 |
| 52 | 08CIM182.2P0 | 9/28/2008  | 4  | 5 | 5 |
| 53 | 08CIM182.2P0 | 9/28/2008  | 5  | 6 | 6 |
| 54 | 08CIM182.2P0 | 9/28/2008  | 6  | 6 | 6 |
| 55 | 08CIM182.2P0 | 9/28/2008  | 7  | 5 | 5 |
| 56 | 08CIM182.2P0 | 9/28/2008  | 8  | 4 | 4 |
| 57 | 08CIM182.2P0 | 9/28/2008  | 9  | 3 | 3 |
| 58 | 08CIM182.2P0 | 9/28/2008  | 10 | 2 | 2 |
| 59 | 08CIM182.2P0 | 9/28/2008  | 11 | 1 | 1 |
| 60 | 08CIM182.2P0 | 9/28/2008  | 12 | 1 | 1 |
| 61 | 08CIM182.2P0 | 9/28/2008  | 13 | 1 | 1 |
| 62 | 08CIM182.2P0 | 9/28/2008  | 14 | 1 | 1 |
| 63 | 08CIM182.2P0 | 9/28/2008  | 15 | 1 | 1 |
| 64 | 08CIM182.2P0 | 9/28/2008  | 16 | 1 | 1 |
| 65 | 08CIM182.2P0 | 9/28/2008  | 17 | 1 | 1 |
| 66 | 08CIM182.2P0 | 9/28/2008  | 18 | 2 | 2 |
| 67 | 08CIM182.2P0 | 9/28/2008  | 19 | 3 | 3 |
| 68 | 08CIM182.2P0 | 9/28/2008  | 20 | 4 | 4 |
| 69 | 08CIM182.2P0 | 9/28/2008  | 21 | 5 | 5 |
| 70 | 08CIM182.2P0 | 9/28/2008  | 22 | 4 | 4 |
| 71 | 08CIM182.2P0 | 9/28/2008  | 23 | 5 | 5 |
| 72 | 08CIM182.2P0 | 9/28/2008  | 24 | 6 | 6 |